



**CORRUGATED
ROOF TILES**



**PANA
ROOF**

CORRUGATED ROOF TILES



LIGHTWEIGHT 6 KG/M², ACOUSTIC AND THERMAL INSULATION 40%, 100 KG LOADING CAPACITY WITH DOLLYS AT 60 - 90 CMS AWAY FROM EACH OTHER, PROVEN WITH FIRE, WATER, HUMIDITY AND CORROSION. CERTIFIED BY ISO9001 AND ISO14001.

CHEMICAL COMPOSITION

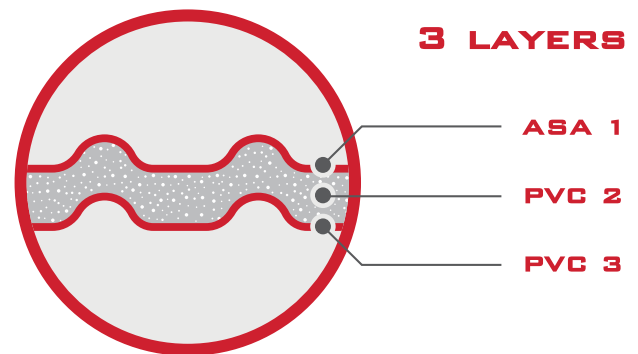

AVAILABLE COLOURS

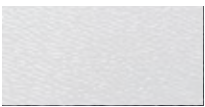

White

RECOMMENDED USES



INDUSTRIAL (WAGON)



COMMERCIAL



GARAGES







OUTDOOR FARMS

QUALITY CONTROLS

QUALITY CONTROL	ASSESSED METHOD	TRIAL CONDITIONS		RESULT	
UV EXPOSURE	ASTM-G154-12	PHASE 1, LAMP TYPE UV-340		E*AB=0,50	
	ASTM-D2244-11	EXPOSURE TIME: 200 HOURS			
TRACTION RESISTANCE	ASTM-D638-10	TRIAL VELOCITY: 50MM/MIN		28 MPA	
FLEXION RESISTANCE	ASTM-D790-10	TRIAL VELOCITY: 1,30MM/MIN; LIGHT: 48MM		50 MPA	
	PROCEDURE A				
IMPACT RESISTANCE	ASTM-D5420-10	GEOMETRY GE		ENERGY BREAKING	TYPE OF FAILURE
				3,000 JOULES	A
THERMAL CONDUCTIVITY	ASTM-C518-10	AVERAGE TEMPERATURE	DIFFERENCE TEMPERATURE	0,325 [W/(MK)]	
		25,48°C	9,36°C		
FLAMMABILITY	UL 94-2013	SAMPLE DIMENSIONS:		V-0	
		129,00 MM X 12,50 MM X 3,00 MM			
EXTREME TEMPERATURE PERFORMANCE	-	EXPOSURE TO EXTREME TEMPERATURES FOR 6 CONSECUTIVE HOURS UNTIL NOTICE CHANGES OF APPEARANCE.		MINIMUM	MAXIMUM
				-36°C	60°C
CHEMICAL RESISTANCE	-	IMMERSION IN ETHANOL SOLUTION AT 70% (V/V) TO 23C FOR 2 HOURS		NO APPARENT CHANGES	
		IMMERSION IN NaOH SOLUTION AT 10% (M/M) TO 23C FOR 2 HOURS			
		IMMERSION IN SATURATED SOLUTION OF NaCl TO 23C FOR 2 HOURS			

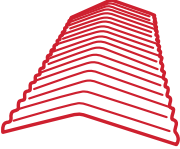
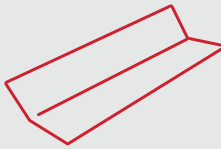
TECHNICAL SPECIFICATIONS

PRODUCT	DESCRIPTION	WEIGHT	LENGTH / WIDTH	FEATURES
	PANA ROOF® CORRUGATED	6 KG/M ²	5.8 M. X 1.13 M.	ASA/PVC 3MM THICK SYNTHETIC ROOF TILE.
	PANA ROOF® TRANSLUCENT CORRUGATED	3 KG/M ²	5.8 M. X 1.13 M.	2 MM UPVC ROOF TILE.
	MAIN RIDGE	4 KG/ML	1.13 M. X 0.62 M.	RIDGE-SHAPED TOOL USED TO COVE EDGES OF PANA ROOF® TILES TO TWO OR MORE WATERS, AT ITS HIGHEST POINT. ANGULAR RANGE OF USE: 140 DEGREES.
	VERTICAL WALL FLASHING	-	1.13 ML.	TOOL THAT ALLOWS THE CORRECT UNION BETWEEN THE CEILING AND A VERTICAL WALL.
	SELF-ADHESIVE BAND	-	5 M	SELF-ADHESIVE BAND THAT ALLOWS SEAL OVERLAPS AND PERFORATIONS TO AVOID LEAKS.
	UPVC SCREWS KIT	0.10 KG/PIECE	2.5" LENGTH 3" LENGTH 4" LENGTH	TOOL WHICH ALLOWS SECURING OF ROOF TILES AND ACCESSORIES.

ROOF TILES DIMENSIONS (TOTAL AND USEFUL)

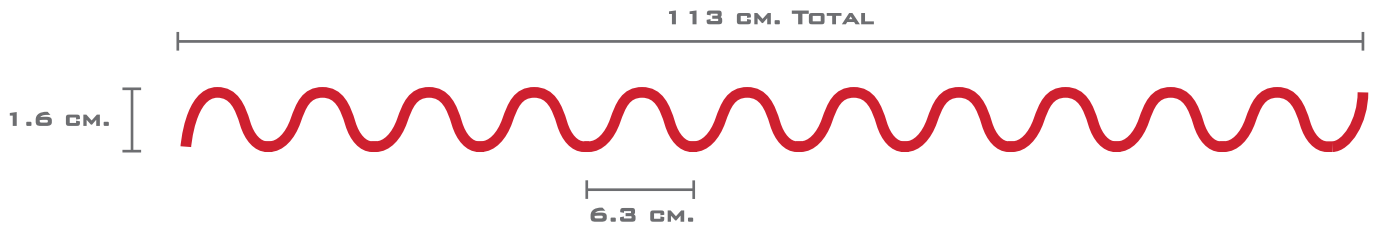

DIMENSIONS TABLE

CORRUGATED ROOF TILES										
ROOF TILE	LENGTH		WIDTH		OVERLAY (M)		TOTAL AREA (M ²)	USEFUL AREA (M ²)	WEIGHT (KG)	CALIBER
	FT	MTS	IN	MTS	LONG	ACROSS				
1	19'	5.80	44"	1.13	0.13	0.15	6.554	5.65	36.5	3 MM

USEFUL AREA OF THE ROOF TILE



MINIMUM INCLINATION OF ROOF TILE

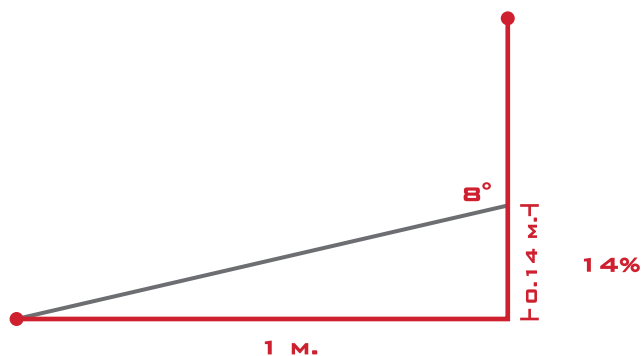

TABLE OF REQUIRED SCREWS

ROOF TILE	SCREWS
19'	16

DISTANCE BETWEEN DOLLIES



INSTALLATION EQUIPMENT AND TOOLS

BEFORE STARTING THE INSTALLATION,
MAKE SURE TO HAVE EVERY REQUIRED
EQUIPMENT AND TOOL AT YOUR
DISPOSAL.

**VENTILATION OF THE TILE IS VERY
IMPORTANT. THE USE OF ALTERNATIVE
INSULATORS IS NOT RECOMMENDED.**

REQUIREMENTS SAFETY EQUIPMENTS

MAKE SURE TO MAKE USE OF
REQUIRED PERSONAL SAFETY
EQUIPMENTS FOR THIS TASK.

LADDER AND/OR SCAFFOLD
WOODEN PLANKS OR DOLLYS
DIE 3/8 FOR SCREW
DRILL
HAND GRINDER (FLEXIBLE)
MEASURING TAPE
DRAWING PEN
ASSEMBLED SCREWS KIT

HELMET
GLOVES
PROTECTIVE SUNGLASSES
SAFETY HARNESS
ROPES



SUGGESTIONS

PERFORM CUTTING OF ROOF TILES ON A SECURE SITE BEFORE INSTALLATION. IT IS ADVISABLE TO CUT ON A FLAT SURFACE AND EACH ROOF TILE TO BE MOVED BY AT LEAST TWO PERSONS, IN ORDER TO AVOID ANY INCIDENTS.

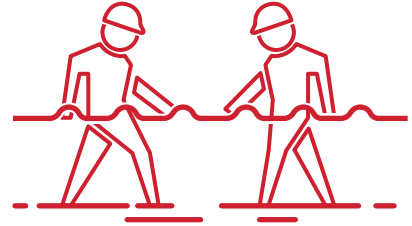

VERIFY PROJECT DIMENSIONS SO EACH ELEMENT IS PLACED ON APPROPRIATE SPOT.

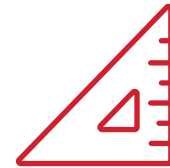

TRY PERFORMING INSTALLATION IN OPPOSITE DIRECTION OF WIND. THEREFORE, FOLLOWING ROOF TILE OVERLAP WILL STAY OVER THE PREVIOUS ONE. PREVENTING WIND GUSTS FROM LIFTING OR PULLING OFF THE ROOF TILES.



BEFORE STARTING THE INSTALLATION, REMEMBER TO REMOVE STICKERS AND LABELS FROM ROOF TILES.



UNLOADING AND HANDLING

USE OF SUPPORTS (BARS, PLANKS OR PALLETS).

SUGGESTIONS TO USE WOODEN PLANKS.

MAKE SURE SUPPORT DOES NOT HAVE ANY SHARP OBJECTS WHICH MAY DAMAGE ROOF TILES.

EVERY 1.25 METERS, A BAR OR PLANK SHOULD BE USED.

VERIFY BARS ARE WIDER THAN ROOF TILE (WITHOUT NAILS, SCREWS, ETC).

IF THE STORAGE IS OUTDOORS, TRY HAVING AN INCLINE STRUCTURE FOR DRAINING WATER.

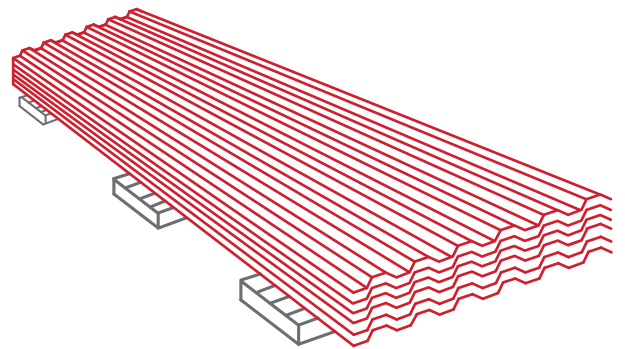
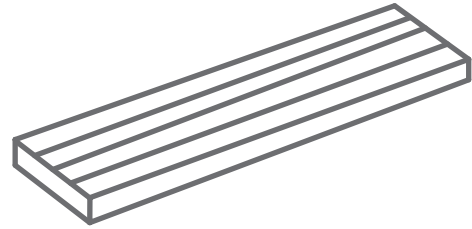

INSTALLATION REQUIREMENTS



ASSEMBLED SCREWS KIT



MEASURING TAPE

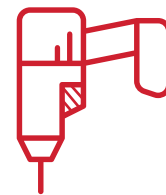

DRILL

INSTALLATION INSTRUCTIONS

1. ONCE FIRST ROOF TILE SPOT IS DEFINED, USE MEASURING TAPE TO SET WHERE **PANA ROOF®** SELF-TAPPING SCREWS WILL GO. AS LONG AS POSSIBLE, HAVE SCREWS PLACED OVER THE RIDGES OF CORRUGATIONS. CONSIDER THAT EVERY INTERSPERSED DOLLY NEEDS AT LEAST FOUR (4) SCREWS.

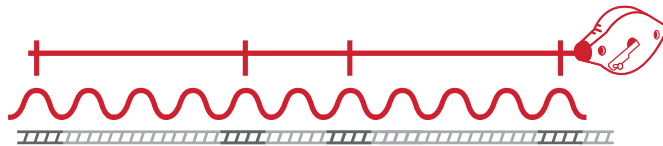

2. DRILL WITH THE DRILL THROUGH HOLE OF RUBBER SEALANT, UNTIL COMPLETE PIERCING OF 2 ROOF TILES AND DOLLY. THE DIAMETER OF THE DRILL HOLES SHOULD BE 2 MM LARGER THAN THE SCREWS.

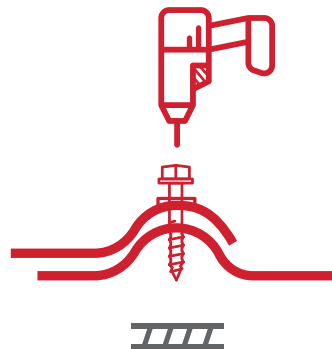

3. ONCE THE SCREW IS INSTALLED, COVER THE SCREW HEAD WITH THE DECORATIVE PLASTIC COVER PROVIDED. IT IS RECOMMENDED TO TIGHTEN THE SCREWS BEFORE FINISHING THE INSTALLATION. THE SCREWS SHOULD NOT BE TOO TIGHT OR TOO LOOSE.



INSTALLATION DRAWING

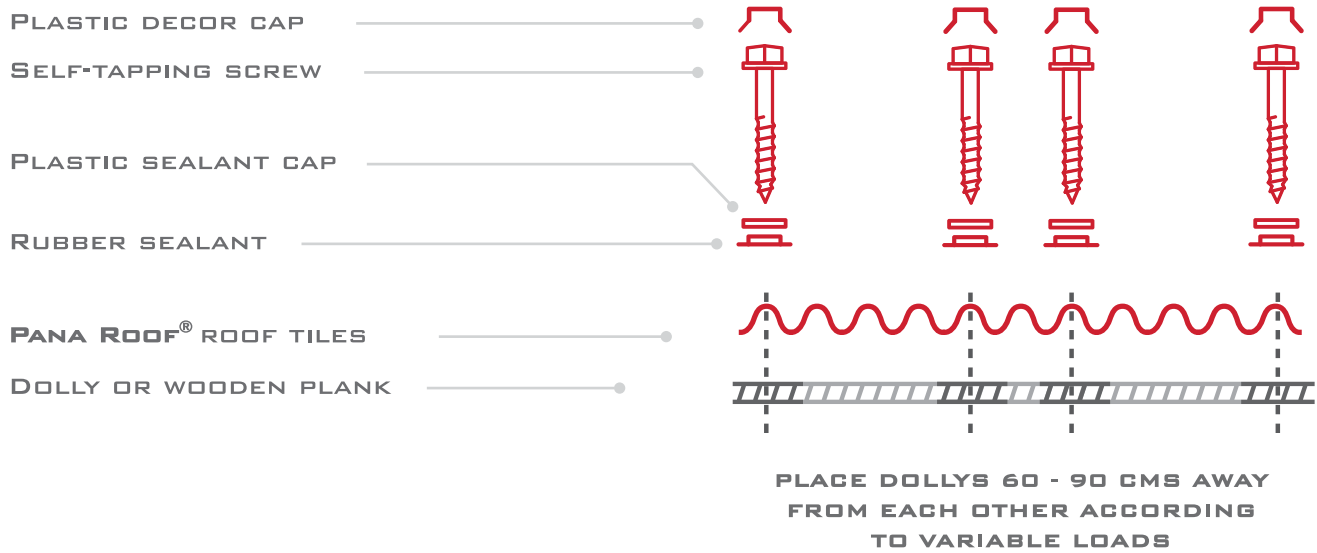

INSTRUCTIONS FOR INSTALLATION OF ROOF TILES

WHEN PANA ROOF® TILES ARE ABOUT TO BE PLACED ON LEFT WATER SIDE OF STRUCTURE, THIS TASK MUST BE DONE FROM LEFT TO RIGHT, IDEALLY KEEPING THE SAME INSTALLATION ORDER OF PANA ROOF® TILES AS ON RIGHT WATER SIDE OF STRUCTURE.

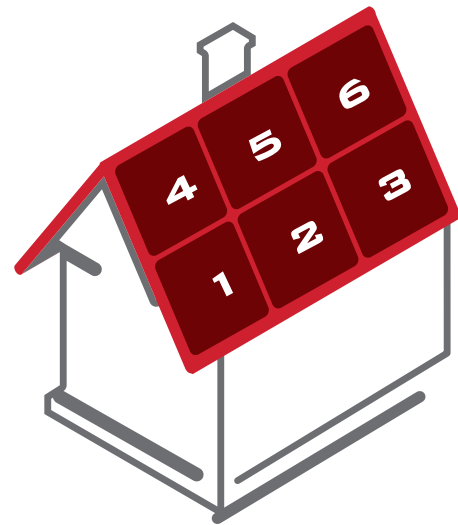



PANA★ROOF

PANA ROOF® RESERVES THE RIGHT TO MODIFY THIS DOCUMENT AT ANY MOMENT WITHOUT PREVIOUS NOTICE, FOR THE SAKE OF DEVELOPING AND CONTINUOUSLY IMPROVING ITS PRODUCTS.

FREE COUNSELING: (507) 393 8844 / 393 8845



WWW.PANAROOF.COM